



## USER MANUAL

SETEBOS-I WIRELESS  
FEATHERWING

2611179024021

VERSION 1.0

OCTOBER 8, 2024

**WÜRTH ELEKTRONIK** MORE THAN YOU EXPECT

\*\*\*\*\*

## **MUST READ**

### **Check for firmware updates**

Before using the product, make sure you use the most recent firmware version, data sheet, and user manual. This is especially important for Wireless Connectivity products that were not purchased directly from Würth Elektronik eiSos. A firmware update on these respective products may be required.

We strongly recommend including the possibility of a firmware update in the customer system design.

## Revision history

Manual version	HW version	Notes	Date
1.0	2.1	Initial version	October 2024

## Abbreviations

Abbreviation	Name	Description
CISPR	Comité International Spécial des Perturbations Radioélectriques	International Special Committee on Radio Interference
ECC	Elliptical Curve Cryptography	
ECDH	Elliptic Curve Diffie Hellman	
EV	Evaluation	
ESD	Electro Static Discharge	
EMC	Electro Magnetic Compatibility	
GND	Ground	
HW	Hardware	
HIGH	High signal level	
IDE	Integrated Development Environment	
IEC	International Electrotechnical Commission	
JST	Japan Solderless Terminal	
JTAG	Joint Test Action Group	
LED	Light Emitting Diode	
LGA	Land Grid Array	
Li-Po	Lithium-Polymer	
LOW	Low signal level	
MEMS	Micro-Electro Mechanical Systems	
PC	Personal Computer	
PCB	Printed Circuit Board	
RPS	Radio Protocol Selection pin	
SCL	Serial Clock	
SDA	Serial Data	
SDK	Software Development Kit	
SPI	Serial Peripheral Interface	
VCC	Voltage Collector Collector	Supply voltage
VDD	Voltage Drain Drain	Supply voltage

# Contents

<b>1</b>	<b>General description</b>	<b>4</b>
1.1	Introduction . . . . .	4
1.2	Block diagram . . . . .	5
1.3	Contents . . . . .	5
<b>2</b>	<b>Functional description</b>	<b>6</b>
2.1	Adafruit Feather . . . . .	6
2.2	Setebos Wireless FeatherWing . . . . .	6
2.2.1	Setebos-I (2611011024020) . . . . .	6
2.2.2	ATECC608B-TNGTLS . . . . .	7
<b>3</b>	<b>Hardware description</b>	<b>9</b>
3.1	Connectors . . . . .	9
3.1.1	Feather connector . . . . .	9
3.1.2	CON2 . . . . .	10
3.2	Configuration via jumpers and solder bridge . . . . .	10
3.2.1	Solder bridge jumpers . . . . .	10
3.2.2	JP2 . . . . .	12
3.3	Push buttons . . . . .	12
3.3.1	S1 . . . . .	13
3.3.2	S2 . . . . .	13
3.4	LEDs . . . . .	13
3.5	Schematics . . . . .	14
3.6	Layout . . . . .	15
3.7	Bill of material . . . . .	17
<b>4</b>	<b>Software description</b>	<b>19</b>
4.1	Software architecture . . . . .	19
4.2	Installing the tools . . . . .	20
4.2.1	IDE . . . . .	20
4.2.2	Installation steps . . . . .	21
4.3	Hardware Setup . . . . .	21
4.4	Running the quick start example . . . . .	21
<b>5</b>	<b>Regulatory compliance information</b>	<b>23</b>
5.1	Exemption clause . . . . .	23
<b>6</b>	<b>Important notes</b>	<b>24</b>
<b>7</b>	<b>Terms of Use for Würth Elektronik eiSos GmbH &amp; Co. KG EV-Boards, evaluation kits and evaluation modules</b>	<b>24</b>
<b>8</b>	<b>Legal notice</b>	<b>26</b>
<b>9</b>	<b>License terms</b>	<b>27</b>
<b>10</b>	<b>References</b>	<b>29</b>

# 1 General description

## 1.1 Introduction

The Würth Elektronik eiSos Setebos-I Wireless FeatherWing is a development board that offers a combination of two different radio protocols in the 2.4 GHz ISM band. It is fully compatible to the popular Adafruit Feather line of development boards and consists of the following primary components:

- Setebos-I (2611011024020) radio module from Würth Elektronik eiSos
- ATECC608B-TNGTLS - Secure element from Microchip Technologies

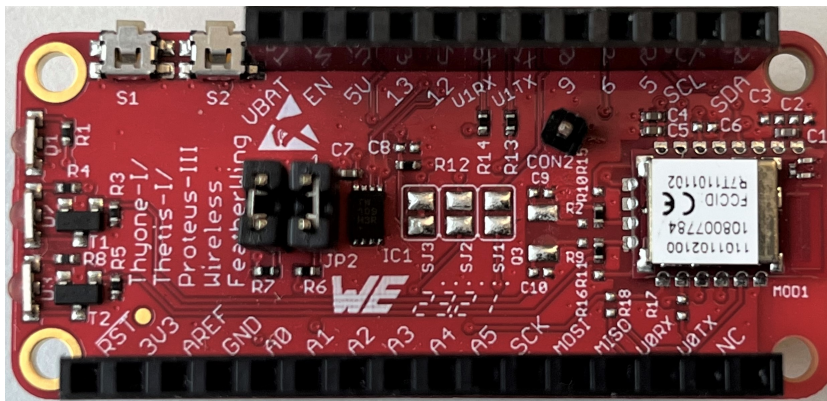

Figure 1: The WE Setebos-I Wireless FeatherWing (2611179024021)

The Setebos-I Wireless FeatherWing can be configured to operate in one of the following modes:

- Bluetooth® LE 5.1 functionality based on the Proteus-III radio module (default) [1].
- Proprietary 2.4 GHz radio based on Thyone-I radio module [2]. The secure element can be used to secure the radio link with authentication and end-to-end encryption.



The Setebos-I Wireless FeatherWing is the direct replacement for the Thyone-I Wireless FeatherWing (2611059021001) and adds the Bluetooth® LE functionality.



The Setebos-I Wireless FeatherWing is configured to start with the Proteus-III Bluetooth® LE 5.1 functionality by default.



For using the proprietary radio protocol based on Thyone-I, the solder bridge jumper SJ4 shall be shorted and pin 5 of the Feather connector shall be pulled to 3.3 V. Refer to chapter 3.2 for further details.

The radio module has a UART interface and the secure element an I<sup>2</sup>C interface and hence can be connected to any of the Feather microcontroller boards. The Arduino (C/C++) drivers and examples (see chapter 4) made available, make it easy to build a prototype to kick-start the application development.

## 1.2 Block diagram

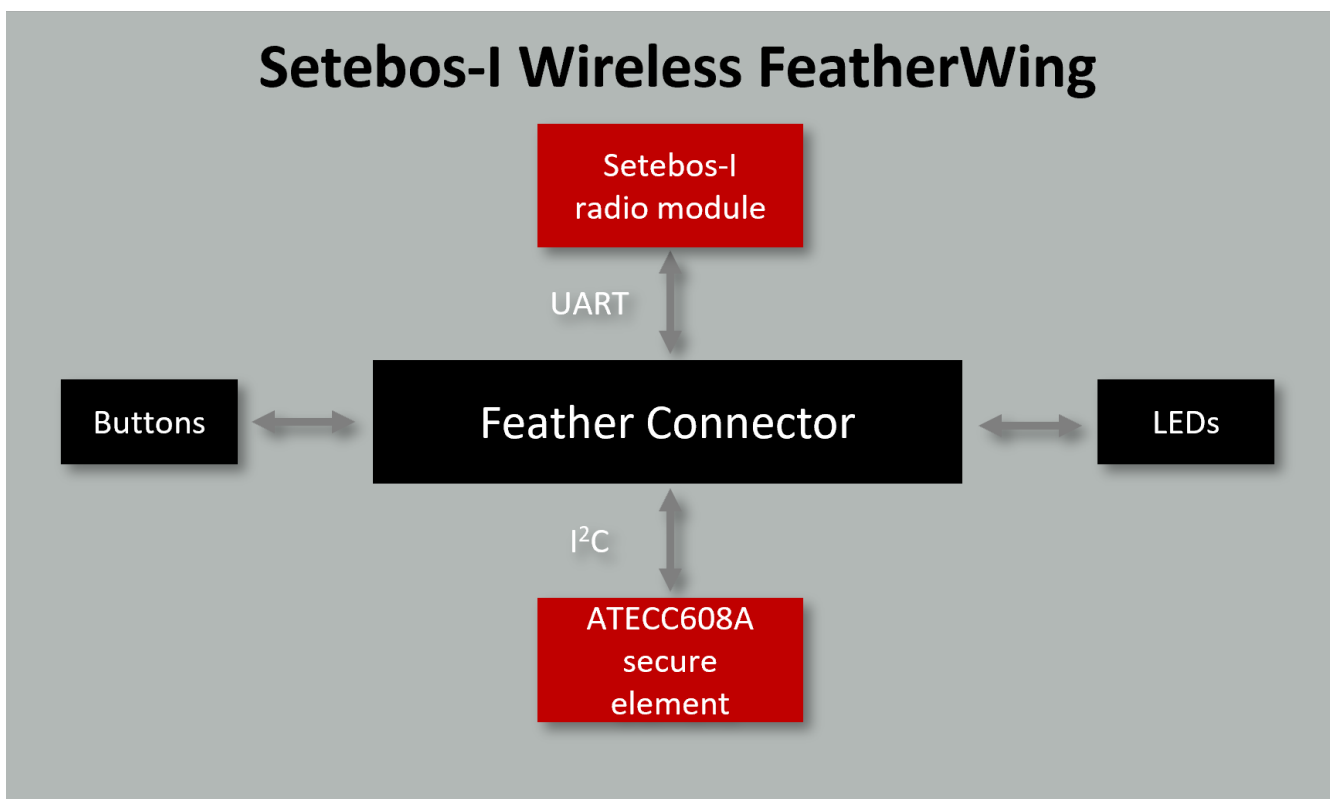

Figure 2: Block diagram - Setebos-I Wireless FeatherWing

## 1.3 Contents

Description	Quantity
Setebos-I Wireless FeatherWing	1
Packaging: ESD safe bag	1

Table 1: Contents 2611179024021

## 2 Functional description

The Setebos-I Wireless FeatherWing was designed with rapid application prototyping in mind. Being fully compatible with the Adafruit ecosystem, this FeatherWing allows the user the flexibility to choose the preferred host microcontroller. The inherent modularity of the ecosystem allows the FeatherWing to be easily integrated into any project.

The next sections provide a brief introduction to Adafruit's Feather ecosystem and details on the Setebos-I radio module and the proprietary secure 2.4 GHz feature using the "Thyone-I" mode in combination with the secure element present on the FeatherWing.

Feel free to check our YouTube channel:

[www.youtube.com/user/WuerthElektronik/videos](http://www.youtube.com/user/WuerthElektronik/videos) for video tutorials, hands-ons and webinars relating to our products.

### 2.1 Adafruit Feather

The Adafruit Feather ecosystem consists of two types of boards apart from a host of accessories:

- **Feather:** Adafruit Feathers are a complete line of development boards from Adafruit that are standalone and stackable. They can be powered either over the on-board micro-USB plugs or using a Li-Po battery. Feathers are portable, flexible and light as their namesake.
- **FeatherWing:** FeatherWings are stackable boards that, when used along with a Feather, add a certain functionality to the system.

The Feather system with more than 50+ Wings, several different types of accessories and arduino/circuit python, based code support, provides a perfect ecosystem for rapid application evaluation. Please refer to [adafruit.com/feather](http://adafruit.com/feather) for more details on the Adafruit Feather ecosystem.

### 2.2 Setebos Wireless FeatherWing

The Setebos-I Wireless FeatherWing consists of the Setebos-I radio module and the ATECC608B secure element. This section provides details regarding these components.

#### 2.2.1 Setebos-I (2611011024020)

The Setebos-I is a radio module for wireless communication between devices such as control systems, remote controls, sensor nodes, etc. Operating in the globally available 2.4 GHz license free band, it combines two radio standards in a single hardware platform. The Setebos-I can be configured to work with either Bluetooth® LE or with WE-ProWare radio stack.

- When the Bluetooth® LE standard is selected, the Setebos-I acts as a Proteus-III radio module.
- When the WE-ProWare radio stack is selected, the Setebos-I acts as a Thyone-I radio module.



Depending on the selected standard, the corresponding module's specifications apply. These are available in the dedicated Proteus-III [1] and Thyone-I [2] user manuals.

Small dimensions (8 x 12 mm), comparable to a nano-sim card, including an on-board PCB antenna, make Setebos-I ideal for small form factor design. The Setebos-I interfaces the host system via serial UART.

### Key features

The Setebos-I offers a wide range of configurable features to suit even the most sophisticated application design. From low power long range to line-powered high throughput, the Setebos-I can be configured to cover a wide range of applications.

**Extremely small dimensions:** Owing to its small size (8 x 12 mm), the module can be easily designed into compact end devices.

**Energy efficient:** The Setebos-I has extremely low current consumption, especially in sleep mode ( $< 0.4 \mu\text{A}$ ), making it suitable for battery driven applications.

**Globally available 2.4 GHz band:** The Setebos-I operates in the 2.4 GHz license free band that allows global deployment of the end-device.

**Smart antenna selection:** The Setebos-I offers the choice of using the on-board PCB antenna for compact designs or connecting an external antenna for applications that require long range.

**Configurable radio profiles:** The module can be configured to operate in 125, 500, 1000 and 2000 kbit/s radio profiles, offering the versatility of long range or high throughput.

**Fast serial interface:** The Setebos-I offers a UART interface to communicate with a host using a user-defined baud rate of up to 1 Mbit/s.

**Embedded security on-module:** The secure bootloader on the module verifies the image signature on boot-up offering tamper protection. The module also supports hardware accelerated end-to-end encryption.

**Additional local/remote GPIOs:** The Setebos-I firmware allows configuration and control of free digital I/O pins on the module via serial or radio interface.

**Transparent mode:** A transparent mode is available out-of-the-box, enabling easy serial cable replacement.

Further details about Setebos-I radio module can be found under [we-online.de/katalog/en/SETEBOS-I](http://we-online.de/katalog/en/SETEBOS-I)

### 2.2.2 ATECC608B-TNGTLS

The ATECC608B-TNGTLS is a pre-provisioned variant of the ATECC608B secure element from Microchip Technologies. The device is configured to make the secure element suitable to some of the most common use cases for IoT applications. It offers a rich set of cryptographic features like key agreement using ECDH, sign-verify mechanism, and encryption/decryption over an easily accessible I<sup>2</sup>C interface. Its tiny form factor and low power consumption make it suitable for a wide variety of battery-driven applications.

**Key features**

- I<sup>2</sup>C interface with one-time changeable I<sup>2</sup>C address
- One permanent P-256 ECC private key fixed at the time of manufacturing
- Three secondary P-256 ECC private keys that can be regenerated by the user
- Signer public key from signer certificate
- X.509 compressed certificate storage

Further details about this secure element can be found under  
[www.microchip.com/wwwproducts/en/ATECC608B](http://www.microchip.com/wwwproducts/en/ATECC608B)

### 3 Hardware description

This section contains a detailed description of the hardware features of the Setebos-I Wireless FeatherWing. The design files for this hardware can be downloaded from [https://github.com/WurthElektronik/FeatherWings/tree/main/Setebos-I\\_FeatherWing](https://github.com/WurthElektronik/FeatherWings/tree/main/Setebos-I_FeatherWing).

#### 3.1 Connectors

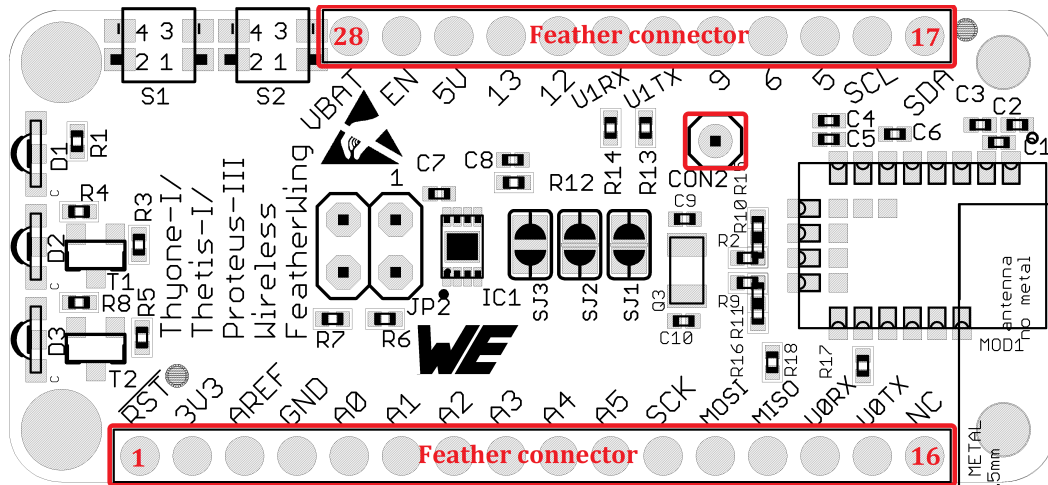

Figure 3: Connectors

##### 3.1.1 Feather connector

This is the standard set of connectors which are used across the Feather ecosystem. The table below describes the functions of each of the 28 pins as applicable to this FeatherWing.

Pin Number	Pin name	Function
1	$\overline{RST}$	Not connected
2	3V3	3.3 V power supply
3	AREF	Not connected
4	GND	Ground
5	A0	(Optional) Module's pin <i>RPS(B1)</i> via solder bridge SJ4
6	A1	Not connected
7	A2	Not connected
8	A3	(Optional) Module's pin <i>MODE_1</i> via solder bridge SJ2
9	A4	Not connected
10	A5	Not connected
11	SCK	Not connected
12	MOSI	Not connected

13	MISO	Not connected
14	U0RX	(Optional) Module's pin <i>UTXD</i> via R18
15	U0TX	(Optional) Module's pin <i>URXD</i> via R17
16	N.C.	Not connected
17	SDA	I <sup>2</sup> C SDA to secure element
18	SCL	I <sup>2</sup> C SCL to secure element
19	5	(Optional) Module's pin <i>/CTS</i> via solder bridge SJ6
20	6	(Optional) Module's pin <i>/RTS</i> via solder bridge SJ5
21	9	(Optional) Module's pin <i>WAKE_UP</i> via solder bridge SJ1
22	U1TX	Module's pin <i>URXD</i> via R13
23	U1RX	Module's pin <i>UTXD</i> via R14
24	12	Not connected
25	13	(Optional) Push button S2 via solder bridge SJ3
26	5 V	Not connected
27	EN	Not connected
28	VBAT	Not connected

### 3.1.2 CON2

Connector CON2 is a single connector that enables connection to the *BOOT* pin via a standard jumper cable.

CON2	Function
-	Direct connection to module's pin <i>BOOT</i>

Table 3: *BOOT* pin connector



By default, CON2 is not mounted. The order code for the matching connector is *6130011121*

## 3.2 Configuration via jumpers and solder bridge

### 3.2.1 Solder bridge jumpers

These solder bridge jumpers enable optional connection between the pins of the radio module to either the switch S2 or to the pins on the Feather connector. Table 4 shows the functionality and the default state of each solder bridge.

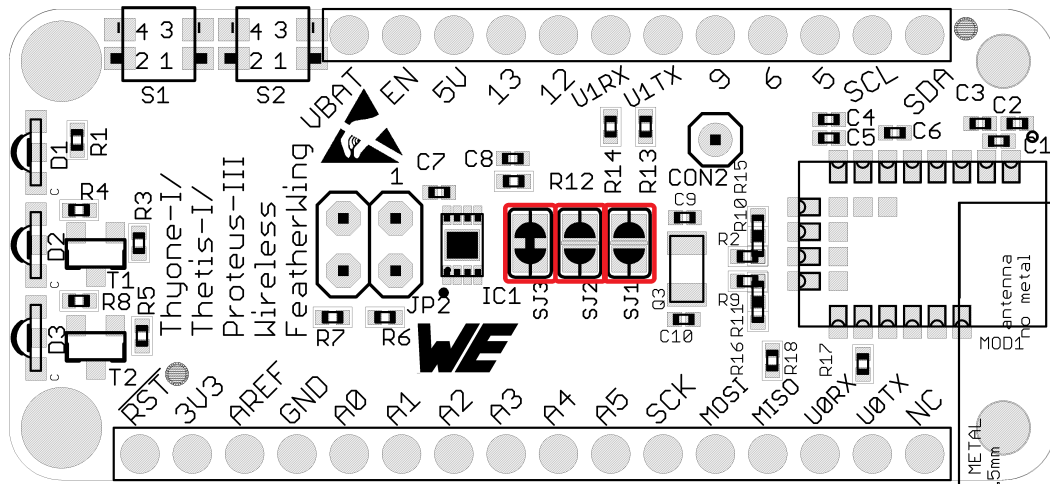

Figure 4: Solder bridges on top

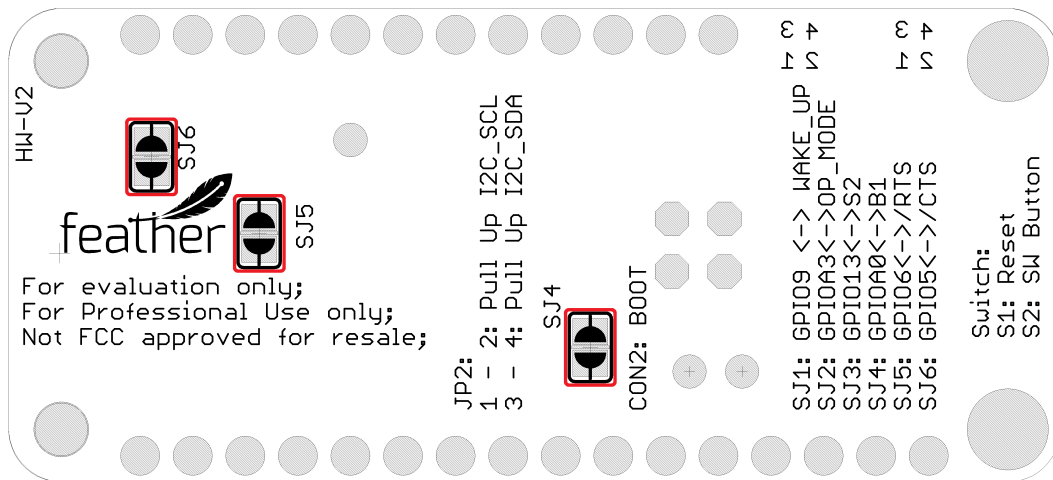

Figure 5: Solder bridges on bottom

SJ	Function	PCB location	Solder bridge shunt (default)
1	WAKE_UP to GPIO9	Top	No
2	MODE_1 to GPIOA3	Top	No
3	Switch S2 to GPIO13	Top	Yes
4	RPS(B1) to GPIO0	Bottom	No
5	/RTS to GPIOA6	Bottom	No
6	/CTS to GPIO5	Bottom	No

Table 4: Solder bridges



The RPS pin shall be used to switch between Bluetooth® LE and proprietary radio protocol. For further details, refer to Setebos-I user manual [3].

### 3.2.2 JP2

The standard I<sup>2</sup>C interface requires the SCL and SDA lines to be pulled up with resistors. These jumpers can be removed in case the pull-ups already exist on the I<sup>2</sup>C bus.

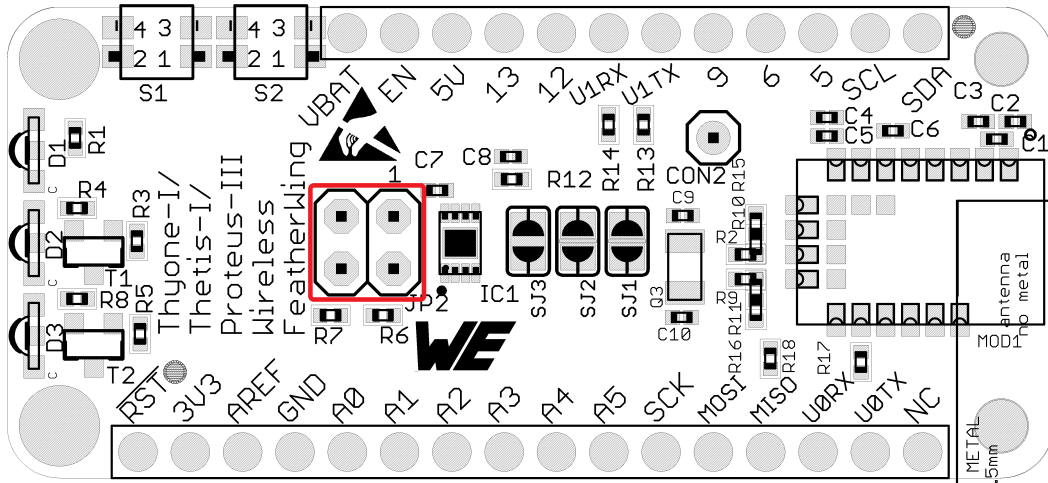

Figure 6: Jumper

JP2	Function	Jumper set (default)
1,2	Connect I <sup>2</sup> C SCL line to a 4.7 kΩ pull up resistor	Yes
3,4	Connect I <sup>2</sup> C SDA line to a 4.7 kΩ pull up resistor	Yes

Table 5: Jumper JP2

### 3.3 Push buttons

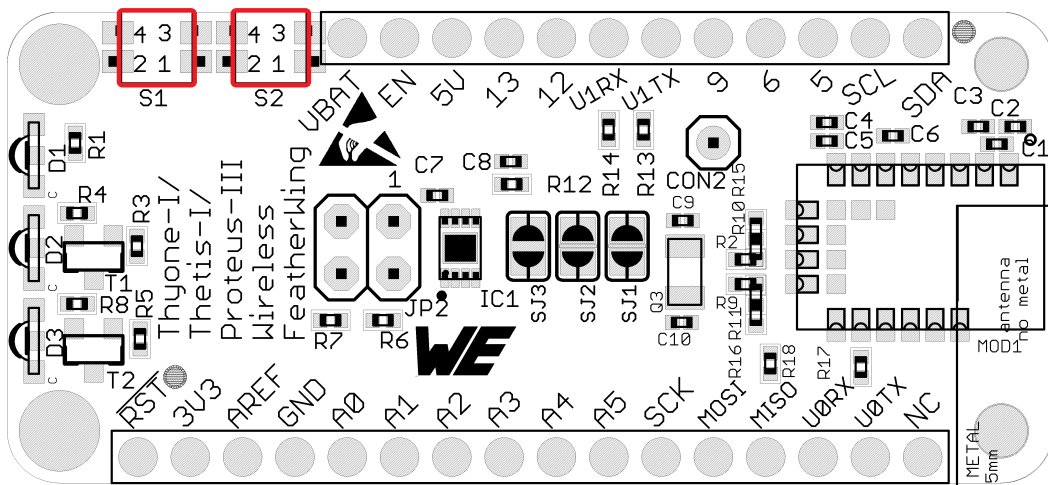

Figure 7: Push buttons

### **3.3.1 S1**

This push button is connected to the /RESET pin of the radio module. Pressing this button resets the module.

### **3.3.2 S2**

S2 is a general purpose push button, which is connected to GPIO 13 by default via the solder bridge jumper(shunt) SJ3.

## **3.4 LEDs**

This FeatherWing has three LEDs. The LED, D1, turns on when the board is supplied with power. The LEDs D2 and D3 are connected to the LED1 and LED2 pins of the Setebos-I radio module. For details on the operation of these LEDs, refer to Setebos-I user manual [3].

### 3.5 Schematics

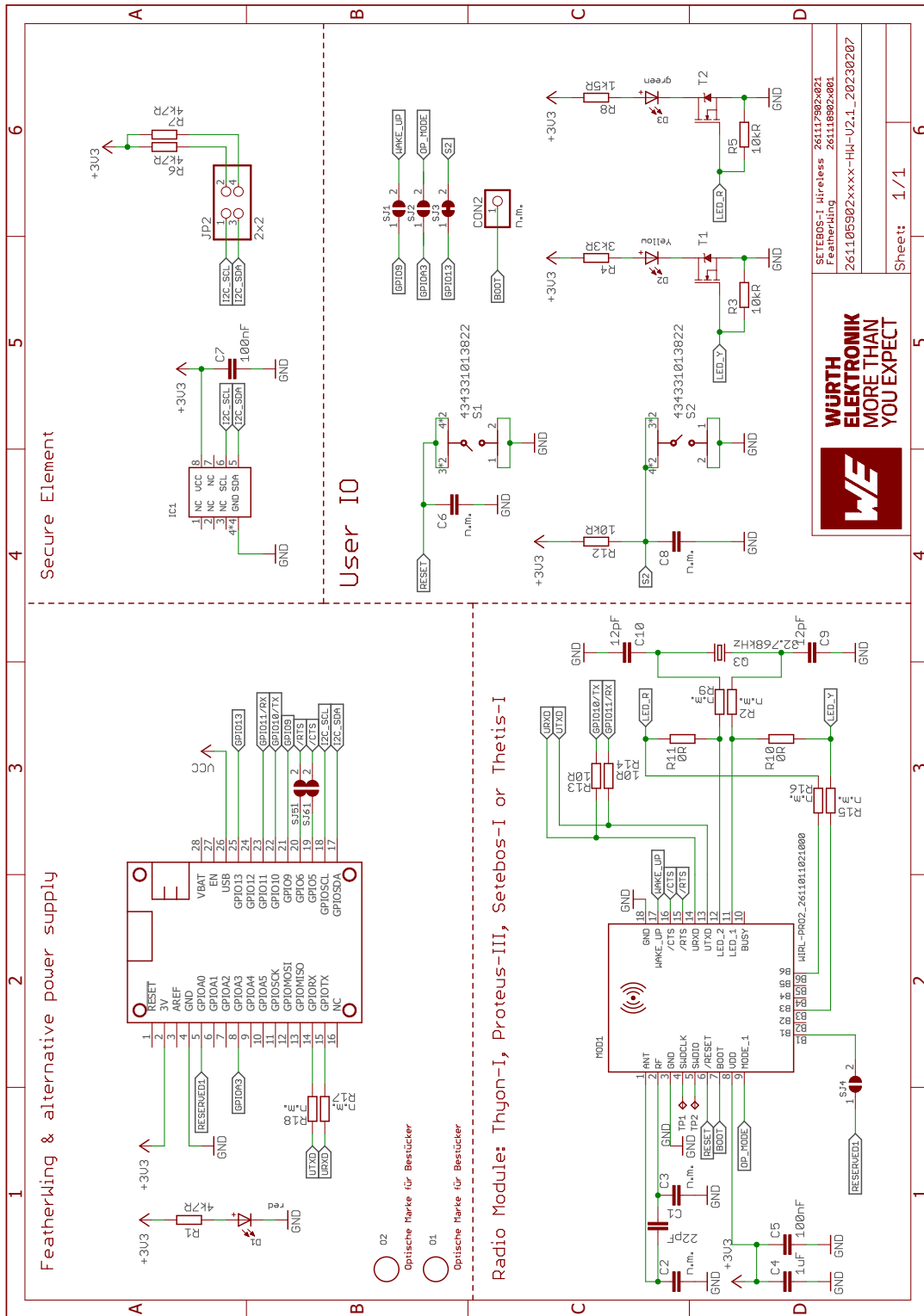

Figure 8: Schematics



### 3.6 Layout

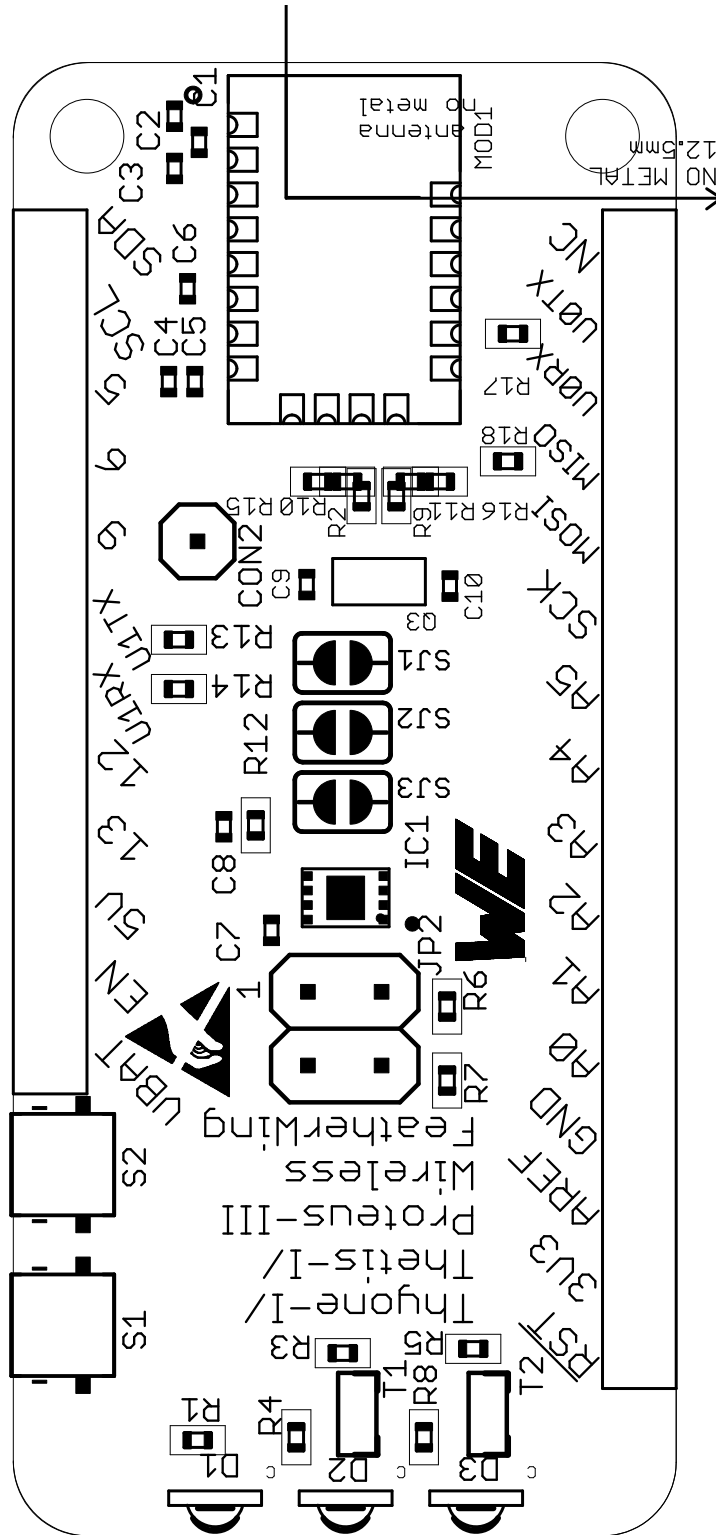

Figure 9: Assembly diagrams

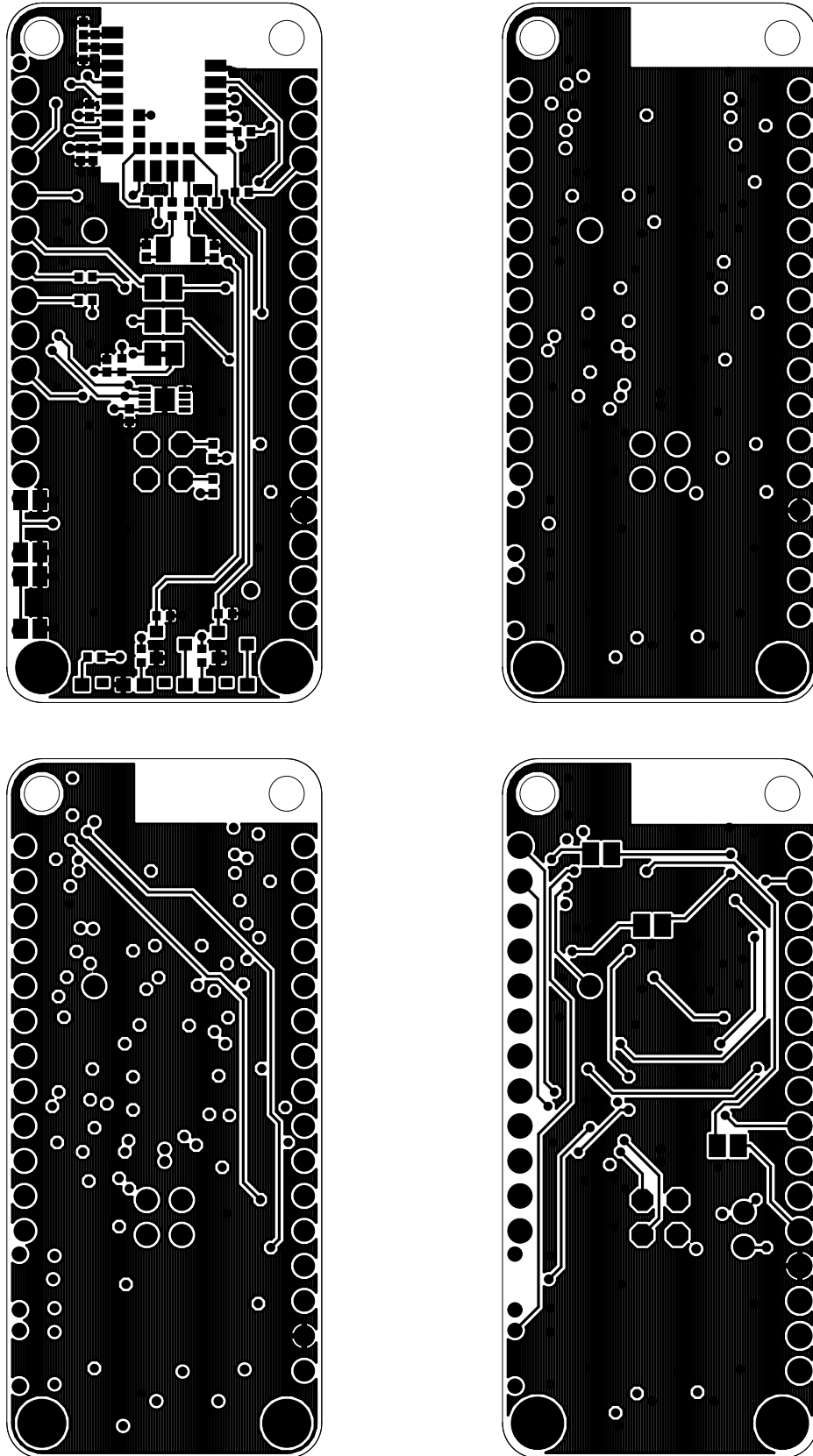

Figure 10: Top layer (upper left), second layer (upper right), third layer (bottom left), fourth layer (bottom right)

### 3.7 Bill of material

Part	Value	Pack	Manufacturer	NR
C1	22pF	0402	Würth Elektronik eiSos	885012005057
C2	n.m.	0402	n.m.	n.m.
C3	n.m.	0402	n.m.	n.m.
C4	1 $\mu$ F	0402	Würth Elektronik eiSos	885012105012
C5	100nF	0402	Würth Elektronik eiSos	885012205037
C6	n.m.	0402	n.m.	n.m.
C7	100nF	0402	Würth Elektronik eiSos	885012205037
C8	n.m.	0402	n.m.	n.m.
C9	n.m.	0402	n.m.	n.m.
C10	n.m.	0402	n.m.	n.m.
CON2	n.m.	0402	n.m.	n.m.
D1	Red	1204	Würth Elektronik eiSos	155124RS73200
D2	Yellow	1204	Würth Elektronik eiSos	155124YS73200
D3	Green	1204	Würth Elektronik eiSos	155124VS73200
IC1	ATECC608B	UDFN-8	Microchip	ATECC608B-TNGTLSU
JP2	2x2	THT	Würth Elektronik eiSos	61300421121
MOD1	WIRL-COMB Setebos-I	SMT	Würth Elektronik eiSos	2611011024020
MS1	header:1 x 12 & 1 x 16	THT	Adafruit	2830
Q3	n.m.	0402	n.m.	n.m.
R1	4.7 k $\Omega$	0402	Yageo	RC0402FR-074K7L
R2	n.m.	0402	n.m.	n.m.
R3	10 k $\Omega$	0402	Yageo	RC0402FR-0710K
R4	3.3 k $\Omega$	0402	Yageo	RC0402FR-073K3L
R5	10 k $\Omega$	0402	Yageo	RC0402FR-0710KL
R6	4.7 k $\Omega$	0402	Yageo	RC0402FR-074K7L
R7	4.7 k $\Omega$	0402	Yageo	RC0402FR-074K7L
R8	1.5 k $\Omega$	0402	Yageo	RC0402FR-071K5L
R9	n.m.	0402	n.m.	n.m.
R10	0 $\Omega$	0402	Yageo	RC0402FR-070RL
R11	0 $\Omega$	0402	Yageo	RC0402FR-070RL
R15	n.m.	0402	n.m.	n.m.

Table 6: Bill of materials part 1

Part	Value	Pack	Manufacturer	NR
R12	10 k $\Omega$	0402	Yageo	RC0402FR-0710K
R13	10 $\Omega$	0402	Yageo	RC0402FR-0710RL
R14	10 $\Omega$	0402	Yageo	RC0402FR-0710RL
R16	n.m.	0402	n.m.	n.m.
R17	n.m.	0402	n.m.	n.m.
R18	n.m.	0402	n.m.	n.m.
S1	434331013822	SMT	Würth Elektronik eiSos	<i>434331013822</i>
S2	434331013822	SMT	Würth Elektronik eiSos	<i>434331013822</i>
T1	BSS138	SOT-23	onsemi	BSS138
T2	BSS138	SOT-23	onsemi	BSS138

Table 7: Bill of materials part 2

## 4 Software description

Würth Elektronik eiSos provides a software development kit (SDK) with examples to support all WE FeatherWings. Here are the salient features of the WE FeatherWing SDK.

- The SDK is open-source and well documented.
- It uses popular open-source tool chain including an IDE.
- The examples are written in Arduino-styled C/C++ for quick prototyping.
- The core components of the SDK are written in pure C to enable easy porting to any microcontroller platform.
- Development platform independent (Windows, Linux or macOS).
- Modular structure of the software stack makes it easy to integrate into any project.

The SDK can be accessed on Github at <https://github.com/WurthElektronik/FeatherWings/>.

### 4.1 Software architecture

The WE FeatherWing SDK is built in a modular way using a set of open-source tools to enable complete flexibility for the user.

The figure 11 shows the architecture of the WE FeatherWing SDK.

- **PlatformIO:** is a cross-platform, cross-architecture, multiple framework professional tool for embedded software development. It provides the tool chain necessary for the software development including building, debugging, code-upload and many more. PlatformIO works well on all the modern operating systems and supports a host of development boards including the Feathers from Adafruit. Further details about PlatformIO can be found under [platformio.org](http://platformio.org)
- **Platform interface:** This layer provides abstraction to the peripheral drivers for the platform being used. Currently, this SDK implements an abstraction to the Arduino peripheral drivers for the Feather M0 express platform.
- **WE SDK:** This is a layer of platform-independent pure C drivers for sensors and wireless connectivity modules from Würth Elektronik eiSos. These drivers implement all the necessary functions to utilize the full feature set of the sensors and wireless connectivity modules. More details on the SDK and downloads under, [we-online.com/wcs-software](http://we-online.com/wcs-software).
- **Board files:** This layer provides abstraction at a board level and provides functions to configure and control individual FeatherWings from WE.
- **User application:** The SDK currently implements a quick start example for each of the FeatherWings.

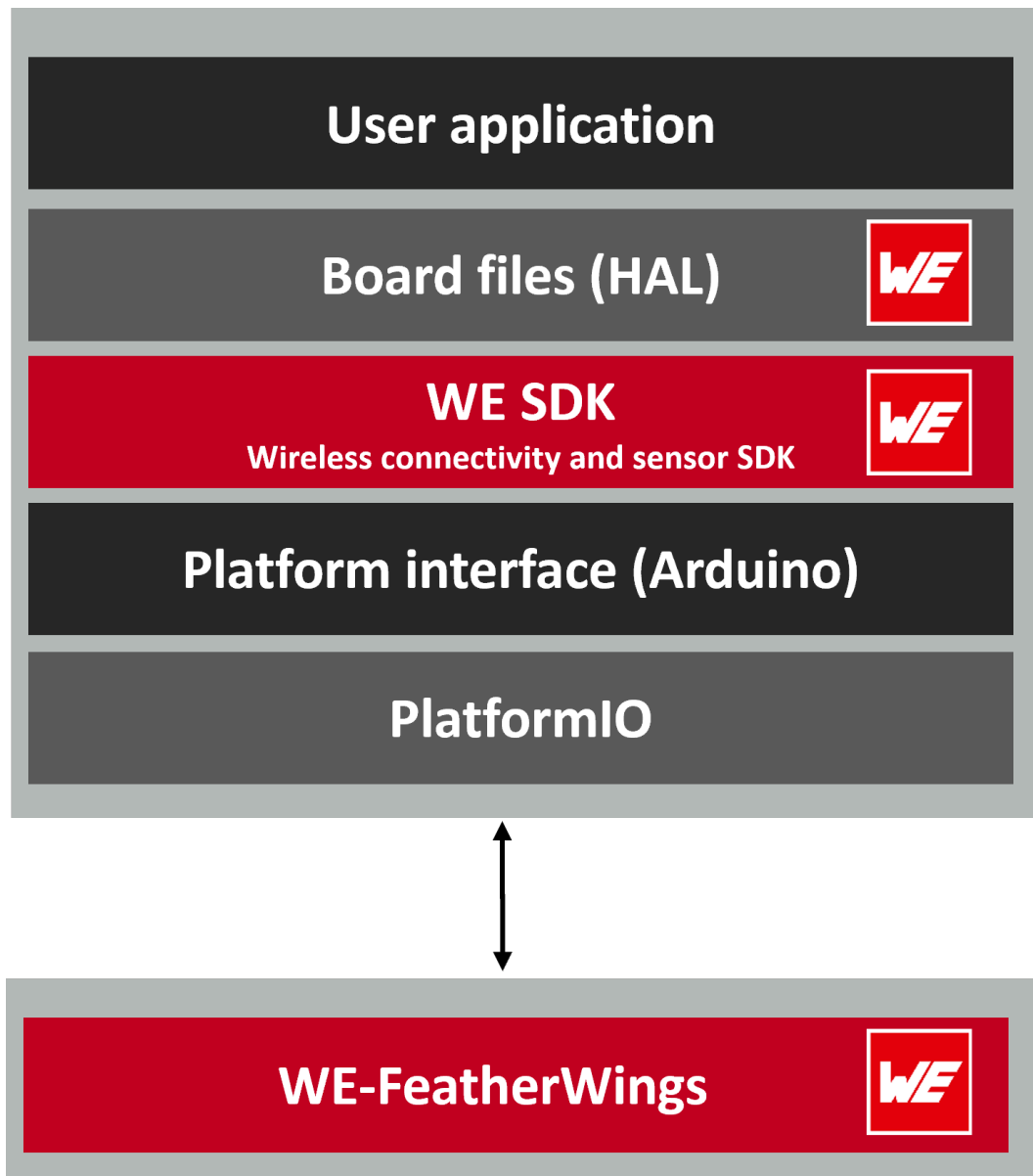

Figure 11: Software architecture

## 4.2 Installing the tools

### 4.2.1 IDE

Although, platformIO provides a versatile command line interface for development, the SDK provides quick start projects for the Visual Studio Code. This popular IDE makes for better code organization as well as code editing. Visual Studio Code is available on all modern operating systems. Support for extensions, built-in Git and a versatile code editor make it a well rounded tool for embedded software development. Please refer to [code.visualstudio.com](https://code.visualstudio.com) for more details on Visual Studio Code.

### 4.2.2 Installation steps

- Install Visual Studio Code on the platform of your choice following the instructions under [code.visualstudio.com/docs](https://code.visualstudio.com/docs)
- Follow the instructions under [platformio.org/install/ide?install=vscode](https://platformio.org/install/ide?install=vscode) to install PlatformIO IDE extension.

## 4.3 Hardware Setup

The quick start examples in the SDK are written to be run on *Adafruit's Feather M0 express*. The hardware setup is as simple as stacking up the FeatherWing on top of the M0 Feather and powering up the board.

## 4.4 Running the quick start example

- Clone or download the WE FeatherWing SDK from Github.  
[github.com/WurthElektronik/FeatherWings](https://github.com/WurthElektronik/FeatherWings)
- Open the workspace of interest with the filename <FeatherWing>.code-workspace in Visual Studio code.
- Build and upload the code from the PlatformIO tab as shown in the Figure 12
- After successful upload, click on Monitor to view the debug logs in the serial terminal (see Figure 12).

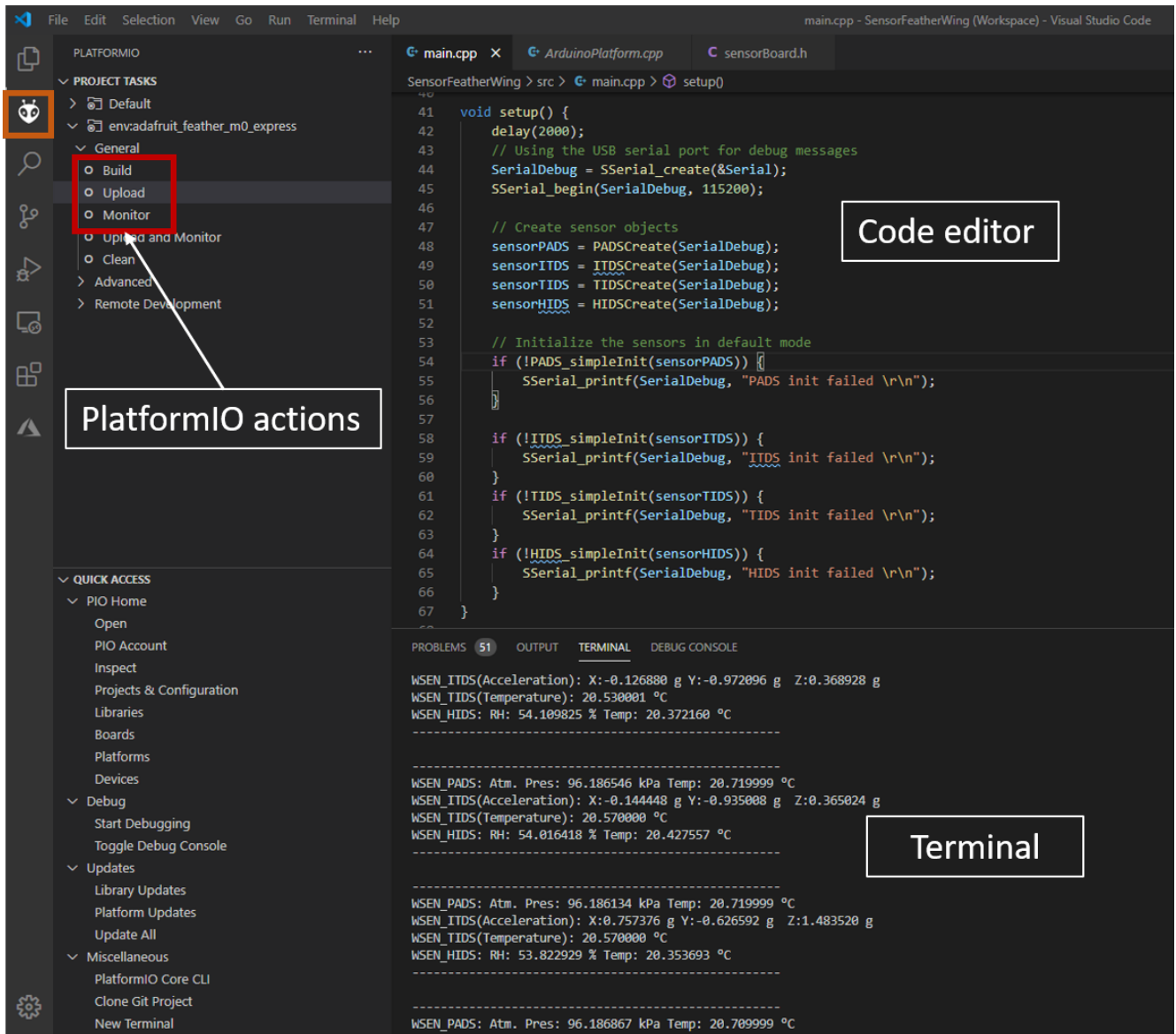

Figure 12: Running the quick start example



## 5 Regulatory compliance information

Pursuant to Article 1 (2.) of the EU directive 2014/53/EU, Article 1 (2.) the directive does not apply to equipment listed in Annex I (4.): custom-built EV-Kits destined for professionals to be used solely at research and development facilities for such purposes.

Nevertheless this EV-Board has been tested to satisfy general EMC requirements. Following standards have been applied:

- IEC 61000-4-3
- IEC 61000-4-4
- IEC 61000-4-6
- CISPR 16-2-1
- CISPR 16-2-3

### 5.1 Exemption clause

Relevant regulation requirements are subject to change. Würth Elektronik eiSos does not guarantee the accuracy of the before mentioned information. Directives, technical standards, procedural descriptions and the like may be interpreted differently by the national authorities. Equally, the national laws and restrictions may vary with the country. In case of doubt or uncertainty, we recommend that you consult with the authorities or official certification organizations of the relevant countries. Würth Elektronik eiSos is exempt from any responsibilities or liabilities related to regulatory compliance.

Notwithstanding the above, Würth Elektronik eiSos makes no representations and warranties of any kind related to their accuracy, correctness, completeness and/or usability for customer applications. No responsibility is assumed for inaccuracies or incompleteness.

## 6 Important notes

The following conditions apply to all goods within the wireless connectivity and sensors product range of Würth Elektronik eiSos GmbH & Co. KG:

### General customer responsibility

Some goods within the product range of Würth Elektronik eiSos GmbH & Co. KG contain statements regarding general suitability for certain application areas. These statements about suitability are based on our knowledge and experience of typical requirements concerning the areas, serve as general guidance and cannot be estimated as binding statements about the suitability for a customer application. The responsibility for the applicability and use in a particular customer design is always solely within the authority of the customer. Due to this fact, it is up to the customer to evaluate, where appropriate to investigate and to decide whether the device with the specific product characteristics described in the product specification is valid and suitable for the respective customer application or not. Accordingly, the customer is cautioned to verify that the documentation is current before placing orders.

### Customer responsibility related to specific, in particular safety-relevant applications

It has to be clearly pointed out that the possibility of a malfunction of electronic components or failure before the end of the usual lifetime cannot be completely eliminated in the current state of the art, even if the products are operated within the range of the specifications. The same statement is valid for all software source code and firmware parts contained in or used with or for products in the wireless connectivity and sensor product range of Würth Elektronik eiSos GmbH & Co. KG. In certain customer applications requiring a high level of safety and especially in customer applications in which the malfunction or failure of an electronic component could endanger human life or health, it must be ensured by most advanced technological aid of suitable design of the customer application that no injury or damage is caused to third parties in the event of malfunction or failure of an electronic component.

### Best care and attention

Any product-specific data sheets, manuals, application notes, PCNs, warnings and cautions must be strictly observed in the most recent versions and matching to the products revisions. These documents can be downloaded from the product specific sections on the wireless connectivity and sensors homepage.

### Customer support for product specifications

Some products within the product range may contain substances, which are subject to restrictions in certain jurisdictions in order to serve specific technical requirements. Necessary information is available on request. In this case, the Business Development Engineer (BDM) or the internal sales person in charge should be contacted who will be happy to support in this matter.

### Product improvements

Due to constant product improvement, product specifications may change from time to time. As a standard reporting procedure of the Product Change Notification (PCN) according to the JEDEC-Standard, we inform about major changes. In case of further queries regarding the PCN, the Business Development Engineer (BDM), the internal sales person or the technical support team in charge should be contacted. The basic responsibility of the customer as per section 6 and 6 remains unaffected.

All software like "wireless connectivity SDK", "Sensor SDK" or other source codes as well as all PC software tools are not subject to the Product Change Notification information process.

### Product life cycle

Due to technical progress and economical evaluation, we also reserve the right to discontinue production and delivery of products. As a standard reporting procedure of the Product Termination Notification (PTN) according to the JEDEC-Standard we will inform at an early stage about inevitable product discontinuance. According to this, we cannot ensure that all products within our product range will always be available. Therefore, it needs to be verified with the Business Development Engineer (BDM) or the internal sales person in charge about the current product availability expectancy before or when the product for application design-in disposal is considered. The approach named above does not apply in the case of individual agreements deviating from the foregoing for customer-specific products. The approach named above does not apply in the case of EV-Boards. EV-Boards may be changed without any notification.

### Property rights

All the rights for contractual products produced by Würth Elektronik eiSos GmbH & Co. KG on the basis of ideas, development contracts as well as models or templates that are subject to copyright, patent or commercial protection supplied to the customer will remain with Würth Elektronik eiSos GmbH & Co. KG. Würth Elektronik eiSos GmbH & Co. KG does not warrant or represent that any license, either expressed or implied, is granted under any patent right, copyright, mask work right, or other intellectual property right relating to any combination, application, or process in which Würth Elektronik eiSos GmbH & Co. KG components or services are used.

### General terms and conditions

Unless otherwise agreed in individual contracts, all orders are subject to the current version of the "General Terms and Conditions of Würth Elektronik eiSos Group", last version available at [www.we-online.com](http://www.we-online.com).

## 7 Terms of Use for Würth Elektronik eiSos GmbH & Co. KG EV-Boards, evaluation kits and evaluation modules

Würth Elektronik eiSos GmbH & Co. KG provide you as a user with technical data (including data sheets), design resources (including reference designs), recommendations for use or other design recommendations, web tools, safety information and other information in the form of evaluation-boards, -kits or -modules (hereinafter jointly referred to as "EVB") in accordance with the terms and conditions contained here. The EVB is provided in the "as is" state. WE disclaims all express and implied warranties, in particular those concerning the suitability for a certain purpose, the absence of defects or non-violation of third-party rights. The EVB is intended for experienced developers to develop

## User manual Setebos-I Wireless FeatherWing

---

their application with WE components. As a user, you are solely responsible for: (1) selection of the appropriate WE components for the application, (2) design, validation and testing the application, and (3) assurance that the application meets the applicable standards and all other safety requirements and other applicable requirements. WE may change the EVB without prior notice. WE grants you permission to use the EVB only for developing an application suitable for using WE components. Any other duplication, representation or transfer of the EVB is expressly prohibited. WE does not grant any licenses for the use of the intellectual property rights from WE or third parties. WE is fully indemnified from all claims, damages, costs, losses and liabilities arising from the misuse of this EVB. The WE components are provided in accordance with WE's conditions of sale or other applicable conditions available either at <https://katalog.we-online.com> or in conjunction with such WE components. WE's provision of the EVB does not constitute an extended warranty in relation to the WE components.

### General warnings

Do not touch the EVB when it is live, and allow charged components, such as capacitors, to discharge completely before handling the EVB. Depending on the individual application, high voltages can occur on the EVB and some components can reach temperatures above 50 °C. Even after disconnecting the EVB from the power source, these conditions remain for a significant time. Please ensure that the appropriate safety precautions are taken when installing and operating this EVB, as one of the following may occur if you handle or use this EVB without observing the relevant safety precautions: - Death - Serious injury - Electric shock - Electric burns - Severe heat burns -

When using the EVB, you undertake to read the instructions for use in full together with the relevant information supplied and/or available on the homepage [www.we-online.de/wcs-manuals](http://www.we-online.de/wcs-manuals) before putting this EVB into operation. The following points have to be observed in particular:

- Do not touch the EVB while it is live.
- The EVB must be fully assembled and all devices to be tested must be connected before voltage is applied to the EVB.
- The EVB should never be left unattended during operation.
- Capacitors must be completely discharged. The capacitors must be actively discharged using a suitable resistor.

### Protection against static electricity

Use the unpackaged product only in ESD protected areas. Wear the ESD personal protective equipment prescribed for these areas. Ground all conductive components, including personnel, as prescribed in ESD protected areas. Ensure that the product is only used by trained personnel.

### Purpose and use

The EVB is not a finished product and is not intended for general use by the consumer. The EVB is intended exclusively for use in the evaluation of WE components in the lab or in development environments by highly qualified technicians or engineers, familiar with the risks involved in handling electrical or mechanical components, systems and subsystems. The use of the EVB is your full and independent responsibility. The EVB is expressly not intended to be installed in a terminal device or to be part of a terminal device in whole or in part. WE reserves the right, at its own discretion, to make corrections, improvements, adjustments or other changes to the EVB or to discontinue the EVB. The EVB is not intended for use in devices and applications for which a higher safety and reliability standard is prescribed. It is also not approved for use in safety-relevant applications or where personal injury or fatal consequences must be expected in the event of failure.

### Operation of the EVB

The EVB may only be operated within the specifications and environmental parameters recommended by WE, as described in the instructions for use. Exceeding the specified parameters (including, but not limited to, input and output voltage, current, power, and ambient conditions) may result in damage to property. If you have questions about these electrical parameters, please contact WE at ([regulatory-compliance@we-online.com](mailto:regulatory-compliance@we-online.com)) prior to connecting peripheral electronics (including the input voltage and intended loads). Any load outside a certain power range may lead to negative consequences, including, but not limited to, unintended or inaccurate evaluations or possibly permanent damage to the EVB or the electronics connected to it. Please ensure that the appropriate safety precautions are taken when working with the EVB, as serious injuries, including severe or even fatal injuries from electric shock or electric burns, may occur if you do not follow the appropriate safety precautions. Under no circumstances should the EVB be touched while live. When the EVB is connected to a power source, some of its components are electrically charged and/or have temperatures above 50 °C. This condition also applies for a short time after disconnecting from the supply voltage until the capacitors are completely discharged and hot components have cooled down. These components include connectors, linear regulators, switching transistors, heat sinks, resistors, diodes, inductors and other components, which can be identified from the documentation in the instructions for use. As with all electronic lab work, only qualified persons with knowledge of electronic performance evaluation, measurement and diagnostic tools, should use the EVB.

### Hazards and warnings

Before putting the EVB into operation, please read the instructions for use and especially the various hazards and warnings described therein. The instructions for use contain important safety information on voltages and temperatures. You take full responsibility and liability for the proper and safe handling of the EVB. You agree to comply with all safety requirements, rules and regulations related to the use of the EVB. You also take full responsibility for: (1) establishing safeguards to ensure that the use of the EVB does not cause damage to property, personal injury or death, even if the EVB does not function as described, intended or expected, (2) the test setup in which the EVB is integrated, all safety requirements, rules and regulations and also that no damage to property, personal injury or other hazardous situation occurs even if the EVB fails, and (3) ensuring the safety of all activities performed by you or your employees when using the EVB. In particular, this means that the technical rules VDE [German Electrical Engineering, Electronic and Information Technology Association] 0105-100 and BGI [German trade association information] 891 (or corresponding applicable safety regulations outside Germany) for the operation of electrical test setups must be observed, the test area is protected against unauthorized access or accidental touching, current limitations, and emergency stop mechanisms are functional and test setups are never operated unattended. If you have any questions about the safe use of the EVB, please contact WE at [regulatory-compliance@we-online.com](mailto:regulatory-compliance@we-online.com) for more information.

### Your responsibility with regard to the applicable laws

- You are responsible for being sufficiently informed about and complying with all international, national, state and local applicable laws, rules and regulations that apply to the handling or use of the EVB by you or your employees.
- The EVB generates, uses and radiates radio frequency energy, but has not been tested for conformity with the limits applicable to the product category, which are applicable according to the European Union regulations for protection against radio frequency interference. Operation of the EVB may cause interference with radio communication. In this case, the costs incurred for necessary measures to remedy the interference are to be borne by the user.

As the EVB is not a finished product, it may not comply with applicable regulatory, safety or certification standards that are normally as-

sociated with other products, such as Directive 2011/65/EC of the European Parliament and of the Council of 8 June 2011 on the restriction of the use of hazardous substances and Directive 2002/96/EC on waste electrical and electronic equipment (WEEE). You take full responsibility for compliance with such standards that apply to the EVB. You also take responsibility for the proper disposal of the components and materials of the EVB.

#### Exclusion of further rights and rights of use for intellectual property of EVB

The sale of an EVB does not constitute the granting by WE of any license or other right of any kind - expressly or implicitly - including, but not limited to, any patent, copyright, trademark or other proprietary rights. All rights from such patent, copyright, trademark or other proprietary rights are expressly reserved by WE. The EVB must not be used in any manner that directly or indirectly infringes any patent, copyright, trademark or other proprietary rights of WE.

#### Warranty of EVB

WE ensures that the EVB meets the specifications given in the instructions for use (within the deviations stated therein) for a period of 12 months from the date of purchase and functions in accordance with the instructions for use. On the basis of the underlying statutory provisions, WE shall rectify defects or offer free replacement of the EVB to which damage occurs that is evidently attributable to a defect for which WE is responsible and is at fault. A warranty claim is subject to the user having complied with the statutory duties of inspection and notification of defects and that the EVB has been received by WE no later than ten (10) days after expiry of the warranty period. This warranty is not transferable to others. This warranty does not apply to defects or impairments in performance resulting from incorrect use, use contrary to WE's instructions, improper installation, improper operation or misuse. WE accepts no liability whatsoever for the failure of equipment or other items not manufactured by or for WE, including, but not limited to, equipment or items to which the EVB is attached or for which the EVB is used. WE DOES NOT GRANT ANY WARRANTIES OR ASSURANCES WHATSOEVER, EXPRESS OR IMPLIED, WITH RESPECT TO THE EVB, INCLUDING, BUT NOT LIMITED TO, ANY IMPLIED WARRANTIES OF MARKETABILITY OR SUITABILITY FOR A PARTICULAR PURPOSE.

#### Limitation of liability for EVB

WE'S OVERALL LIABILITY FOR DAMAGE CAUSED BY WE IS LIMITED TO DAMAGE THAT TYPICALLY OCCURS. WE DOES NOT ACCEPT ANY LIABILITY FOR LOSS OF PROFIT, CONSEQUENTIAL OR SPECIAL LOSSES, OR SPECIAL, INDIRECT, INCIDENTAL AND CONSEQUENTIAL DAMAGE. HOWEVER, THIS LIMITATION OF LIABILITY DOES NOT APPLY IN THE CASE OF INTENTIONAL OR GROSSLY NEGLIGENT ACTS AND FOR THE DAMAGE RESULTING FROM LOSS OF LIFE, PHYSICAL INJURY, HARM TO HEALTH OR IN CASE OF LEGAL MANDATORY LIABILITY [AS IN GERMAN PRODUCT LIABILITY LAW, ProdHaftG].

## 8 Legal notice

#### Exclusion of liability

Würth Elektronik eiSos GmbH & Co. KG considers the information in this document to be correct at the time of publication. However, Würth Elektronik eiSos GmbH & Co. KG reserves the right to modify the information such as technical specifications or functions of its products or discontinue the production of these products or the support of one of these products without any written announcement or notification to customers. The customer must make sure that the information used corresponds to the latest published information. Würth Elektronik eiSos GmbH & Co. KG does not assume any liability for the use of its products. Würth Elektronik eiSos GmbH & Co. KG does not grant licenses for its patent rights or for any other of its intellectual property rights or third-party rights.

Notwithstanding anything above, Würth Elektronik eiSos GmbH & Co. KG makes no representations and/or warranties of any kind for the provided information related to their accuracy, correctness, completeness, usage of the products and/or usability for customer applications. Information published by Würth Elektronik eiSos GmbH & Co. KG regarding third-party products or services does not constitute a license to use such products or services or a warranty or endorsement thereof.

#### Suitability in customer applications

The customer bears the responsibility for compliance of systems or units, in which Würth Elektronik eiSos GmbH & Co. KG products are integrated, with applicable legal regulations. Customer acknowledges and agrees that it is solely responsible for compliance with all legal, regulatory and safety-related requirements concerning its products, and any use of Würth Elektronik eiSos GmbH & Co. KG components in its applications, notwithstanding any applications-related information or support that may be provided by Würth Elektronik eiSos GmbH & Co. KG. Customer represents and agrees that it has all the necessary expertise to create and implement safeguards which anticipate dangerous consequences of failures, monitor failures and their consequences lessen the likelihood of failures that might cause harm and take appropriate remedial actions. The customer will fully indemnify Würth Elektronik eiSos GmbH & Co. KG and its representatives against any damages arising out of the use of any Würth Elektronik eiSos GmbH & Co. KG components in safety-critical applications.

#### Trademarks

AMBER wireless is a registered trademark of Würth Elektronik eiSos GmbH & Co. KG. All other trademarks, registered trademarks, and product names are the exclusive property of the respective owners.

#### Usage restriction

Würth Elektronik eiSos GmbH & Co. KG products have been designed and developed for usage in general electronic equipment only. This product is not authorized for use in equipment where a higher safety standard and reliability standard is especially required or where a failure of the product is reasonably expected to cause severe personal injury or death, unless the parties have executed an agreement specifically governing such use. Moreover, Würth Elektronik eiSos GmbH & Co. KG products are neither designed nor intended for use in areas such as military, aerospace, aviation, nuclear control, submarine, transportation (automotive control, train control, ship control), transportation signal, disaster prevention, medical, public information network etc. Würth Elektronik eiSos GmbH & Co. KG must be informed about the intent of such usage before the design-in stage. In addition, sufficient reliability evaluation checks for safety must be performed on every electronic component, which is used in electrical circuits that require high safety and reliability function or performance. By using Würth Elektronik eiSos GmbH & Co. KG products, the customer agrees to these terms and conditions.

## 9 License terms

These License terms will take effect upon the purchase and usage of the Würth Elektronik eiSos GmbH & Co. KG wireless connectivity products. You hereby agree that these license terms are applicable to the product and the incorporated software, firmware and source codes (collectively, "Software") made available by Würth Elektronik eiSos in any form, including but not limited to binary, executable or source code form. The software included in any Würth Elektronik eiSos wireless connectivity product is purchased to you on the condition that you accept the terms and conditions of these license terms. You agree to comply with all provisions under these license terms.

### Limited license

Würth Elektronik eiSos hereby grants you a limited, non-exclusive, non-transferable and royalty-free license to use the software and under the conditions that will be set forth in these license terms. You are free to use the provided software only in connection with one of the products from Würth Elektronik eiSos to the extent described in these license terms. You are entitled to change or alter the source code for the sole purpose of creating an application embedding the Würth Elektronik eiSos wireless connectivity product. The transfer of the source code to third parties is allowed to the sole extent that the source code is used by such third parties in connection with our product or another hardware provided by Würth Elektronik eiSos under strict adherence of these license terms. Würth Elektronik eiSos will not assume any liability for the usage of the incorporated software and the source code. You are not entitled to transfer the source code in any form to third parties without prior written consent of Würth Elektronik eiSos.

You are not allowed to reproduce, translate, reverse engineer, decompile, disassemble or create derivative works of the incorporated software and the source code in whole or in part. No more extensive rights to use and exploit the products are granted to you.

### Usage and obligations

The responsibility for the applicability and use of the Würth Elektronik eiSos wireless connectivity product with the incorporated firmware in a particular customer design is always solely within the authority of the customer. Due to this fact, it is up to you to evaluate and investigate, where appropriate, and to decide whether the device with the specific product characteristics described in the product specification is valid and suitable for your respective application or not.

You are responsible for using the Würth Elektronik eiSos wireless connectivity product with the incorporated firmware in compliance with all applicable product liability and product safety laws. You acknowledge to minimize the risk of loss and harm to individuals and bear the risk for failure leading to personal injury or death due to your usage of the product.

Würth Elektronik eiSos' products with the incorporated firmware are not authorized for use in safety-critical applications, or where a failure of the product is reasonably expected to cause severe personal injury or death. Moreover, Würth Elektronik eiSos' products with the incorporated firmware are neither designed nor intended for use in areas such as military, aerospace, aviation, nuclear control, submarine, transportation (automotive control, train control, ship control), transportation signal, disaster prevention, medical, public information network etc. You shall inform Würth Elektronik eiSos about the intent of such usage before design-in stage. In certain customer applications requiring a very high level of safety and in which the malfunction or failure of an electronic component could endanger human life or health, you must ensure to have all necessary expertise in the safety and regulatory ramifications of your applications. You acknowledge and agree that you are solely responsible for all legal, regulatory and safety-related requirements concerning your products and any use of Würth Elektronik eiSos' products with the incorporated firmware in such safety-critical applications, notwithstanding any applications-related information or support that may be provided by Würth Elektronik eiSos. **YOU SHALL INDEMNIFY WÜRTH ELEKTRONIK EISOS AGAINST ANY DAMAGES ARISING OUT OF THE USE OF WÜRTH ELEKTRONIK EISOS' PRODUCTS WITH THE INCORPORATED FIRMWARE IN SUCH SAFETY-CRITICAL APPLICATIONS.**

### Ownership

The incorporated firmware created by Würth Elektronik eiSos is and will remain the exclusive property of Würth Elektronik eiSos.

### Firmware update(s)

You have the opportunity to request the current and actual firmware for a bought wireless connectivity product within the time of warranty. However, Würth Elektronik eiSos has no obligation to update a modules firmware in their production facilities, but can offer this as a service on request. The upload of firmware updates falls within your responsibility, e.g. via ACC or another software for firmware updates. Firmware updates will not be communicated automatically. It is within your responsibility to check the current version of a firmware in the latest version of the product manual on our website. The revision table in the product manual provides all necessary information about firmware updates. There is no right to be provided with binary files, so called "firmware images", those could be flashed through JTAG, SWD, Spi-Bi-Wire, SPI or similar interfaces.

### Disclaimer of warranty

THE FIRMWARE IS PROVIDED "AS IS". YOU ACKNOWLEDGE THAT WÜRTH ELEKTRONIK EISOS MAKES NO REPRESENTATIONS AND WARRANTIES OF ANY KIND RELATED TO, BUT NOT LIMITED TO THE NON-INFRINGEMENT OF THIRD PARTIES' INTELLECTUAL PROPERTY RIGHTS OR THE MERCHANTABILITY OR FITNESS FOR YOUR INTENDED PURPOSE OR USAGE. WÜRTH ELEKTRONIK EISOS DOES NOT WARRANT OR REPRESENT THAT ANY LICENSE, EITHER EXPRESS OR IMPLIED, IS GRANTED UNDER ANY PATENT RIGHT, COPYRIGHT, MASK WORK RIGHT, OR OTHER INTELLECTUAL PROPERTY RIGHT RELATING TO ANY COMBINATION, MACHINE, OR PROCESS IN WHICH THE WÜRTH ELEKTRONIK EISOS' PRODUCT WITH THE INCORPORATED FIRMWARE IS USED. INFORMATION PUBLISHED BY WÜRTH ELEKTRONIK EISOS REGARDING THIRD-PARTY PRODUCTS OR SERVICES DOES NOT CONSTITUTE A LICENSE FROM WÜRTH ELEKTRONIK EISOS TO USE SUCH PRODUCTS OR SERVICES OR A WARRANTY OR ENDORSEMENT THEREOF.

### Limitation of liability

Any liability not expressly provided by Würth Elektronik eiSos shall be disclaimed.

You agree to hold us harmless from any third-party claims related to your usage of the Würth Elektronik eiSos' products with the incorporated firmware, software and source code. Würth Elektronik eiSos disclaims any liability for any alteration, development created by you or your customers as well as for any combination with other products.

### Applicable law and jurisdiction

Applicable law to these license terms shall be the laws of the Federal Republic of Germany. Any dispute, claim or controversy arising out of or relating to these license terms shall be resolved and finally settled by the court competent for the location of Würth Elektronik eiSos registered

office.

### Severability clause

If a provision of these license terms is or becomes invalid, unenforceable or null and void, this shall not affect the remaining provisions of the terms. The parties shall replace any such provisions with new valid provisions that most closely approximate the purpose of the terms.

### Miscellaneous

Würth Elektronik eiSos reserves the right at any time to change these terms at its own discretion. It is your responsibility to check at Würth Elektronik eiSos homepage for any updates. Your continued usage of the products will be deemed as the acceptance of the change.

We recommend you to be updated about the status of new firmware and software, which is available on our website or in our data sheet and manual, and to implement new software in your device where appropriate.

By ordering a product, you accept these license terms in all terms.

## 10 References

- [1] Würth Elektronik. Proteus-III user manual. <https://www.we-online.de/katalog/de/manual/2611011024000>.
- [2] Würth Elektronik. Thyone-I user manual. <https://www.we-online.de/katalog/de/manual/2611011021000>.
- [3] Würth Elektronik. Setebos-I user manual. <https://www.we-online.de/katalog/de/manual/2611011024020>.

## List of Figures

1	The WE Setebos-I Wireless FeatherWing (2611179024021) . . . . .	4
2	Block diagram - Setebos-I Wireless FeatherWing . . . . .	5
3	Connectors . . . . .	9
4	Solder bridges on top . . . . .	11
5	Solder bridges on bottom . . . . .	11
6	Jumper . . . . .	12
7	Push buttons . . . . .	12
8	Schematics . . . . .	14
9	Assembly diagrams . . . . .	15
10	Top layer (upper left), second layer (upper right), third layer (bottom left), fourth layer (bottom right) . . . . .	16
11	Software architecture . . . . .	20
12	Running the quick start example . . . . .	22

## List of Tables

1	Contents 2611179024021 . . . . .	5
3	<i>BOOT</i> pin connector . . . . .	10
4	Solder bridges . . . . .	11
5	Jumper JP2 . . . . .	12
6	Bill of materials part 1 . . . . .	17
7	Bill of materials part 2 . . . . .	18





**Contact**

Würth Elektronik eiSos GmbH & Co. KG  
Division Wireless Connectivity & Sensors

Max-Eyth-Straße 1  
74638 Waldenburg  
Germany

Tel.: +49 651 99355-0  
Fax.: +49 651 99355-69  
[www.we-online.com/wireless-connectivity](http://www.we-online.com/wireless-connectivity)

**WÜRTH ELEKTRONIK** MORE THAN YOU EXPECT